

PHILIPS

VideoTracer

音视频记录仪

VTR8410

使用手册

User manual



目录

1 欢迎	6	5 登录执法仪	12
1.1 产品特点	6	6 录像	13
2 重要须知	7	7 拍照	15
2.1 安全	7	8 录音	16
2.2 听力保护	7	9 视频模式	18
2.3 录音的法律限制	7	9.1 视频播放	19
2.4 后台数据	7	10 照片模式	20
2.5 所用符号标记	8	11 语音模式	21
3 您的音视频记录仪	9	12 视频通话功能	23
3.1 设备包含	9	13 集群对讲功能	24
3.2 主机概览	9	13.1 组群对讲	24
4 开始使用	10		
4.1 开 / 关机	10		
4.2 充电方法	11		
4.3 连接电脑	11		

13.2 单一对讲	25	18.8 其他设置	33
		18.9 版本更新	33
14 GPS 定位	26		
15 在线翻译	27	19 背夹的装取	34
		19.1 安装背夹	34
		19.2 取下背夹	34
16 语音转文本	29		
17 影音设置	30	20 背夹的佩戴方式	35
17.1 视频分辨率	30		
17.2 照片分辨率	30	21 常见问题	36
17.3 文件时长	30	21.1 无法启动执法仪	36
		21.2 显示时间 / 日期不正确	36
		21.3 拍照 / 录像图像模糊, 不清楚	36
		21.4 执法仪无法录音或者录像	36
		21.5 执法仪无法播放录音或者录像	36
		21.6 执法仪死机后如何处理	36
18 设置	31		
18.1 文件上传	31	22 技术参数	37
18.2 WIFI 设置	32	22.1 存储器	37
18.3 移动网络设置	32	22.2 尺寸和重量	37
18.4 流量使用情况	32	22.3 系统要求	37
18.5 音量设置	32		
18.6 日期设置	32		
18.7 显示设置	32		

22.4 录音	37
22.5 运行条件	37

1 欢迎

欢迎来到飞利浦世界！您能选择和购买飞利浦的产品，我们非常高兴。您可在我们的官方网站上获得飞利浦公司的全方位技术支持，如：使用手册、软件下载、保修信息等。

www.philips.com

1.1 产品特点

- 前后摄像头：可切换摄像头录像、拍照。
- 语音操控：语音唤醒录像 / 录音 / 拍照等。
- 在线翻译：支持在线同步多语言翻译。
- 语音转文本：录音文件可以转文本。
- 一键录音：仅仅按下录音键即可实现录音，再按一下录音键保存录音。
- 一键录像：仅仅按下录像键即可实现录像，再按一下录像键保存录像。
- 一键拍照：仅仅按下拍照键即可实现拍照功能。
- 一键视频键：仅仅按下视频键即可和调度平台进行视频通话。
- 一键 SOS：仅仅按下 SOS 键即可上报信息到调度平台（需要连网登录账号后，一键才能响应功能，没有登录时按键会提示“未连接服务器”）。
- 一键组群对讲：仅仅按下 PTT 键可直接进入对组群对讲。
- 真正采用立体声录音的音视频记录仪。
- 采用智能音频编解码器，双咪头主动降噪，声音更清晰。
- 160° 超大广角镜头，录像无死角。
- 双滤光片切换器，白天不偏色，夜晚更清晰。
- 字符叠加功能，所有视频和照片都附加时间、产品编号、使用者编号等信息，无法剪辑，更具法定证据效力。
- 超长文件名，所有录像文件的文件名都包含产品编号、时间、使用者编号等信息，方便数据存档、检索。
- 录像资料自动分割保存，防止错误操作造成资料丢失。
- 外置存储卡，最大支持 256G。
- 高清扬声器：采用高品质振动喇叭，无论播放录音文件或录像文件，都给人身临其境的感受。
- 使用高速 USB 2.0 快速存取音视频文件和数据。
- 可作为大容量的 USB 存储设备，确保最大的兼容性。

2 重要须知

2.1 安全



小心

- 特别声明：使用本产品前请仔细阅读本说明书，如因人为操作或不可抗力因素而导致数据丢失，本公司一概不予负责。特别提醒用户小心操作，注意将资料另外备份。
- 显示图像仅作参考。飞利浦保留更改颜色 / 外观 / 设计 / 参数 / 产品功能的权利，硬件、软件、APP 如有更新，恕不另行通知。

2.2 听力保护

使用耳机时请遵守下列原则：

- 调整至合适的音量，切勿长时间使用耳机。
- 特别需要注意，切勿将音量调至耳朵所能承受的范围之外。
- 切勿将音量调至盖过周边环境的声音。
- 在危险情况下请小心或暂停使用耳机。
- 在驾驶汽车、骑自行车、玩滑板时，切勿使用耳机。否则会

导致交通意外，且违反相关法律法规。

2.3 录音的法律限制

- 本设备录音功能的使用可能受限于所在国家法律的限制。录制他人谈话或者课程时应当尊重他人隐私及第三方人权。
- 请注意，在部分国家，当录制用户与他人通话时，用户应根据法律要求通知对方，否则该录音行为将被视为不合法。请在录音前通知使用人所在国家该录音数据使用的合法性。

2.4 后台数据

- 自系统激活日起，本公司可以免费提供一年服务，到期如需继续提供服务，请致电：400-800-7890
- 后台系统仅保存最近 3 天的音视频采集数据，请确保有效数据备份，如因逾期造成的数据丢失，我司不负任何责任。



注意

- 64GB 以上的 TF 卡，初次使用须在本机格式化。
- 格式化之前请确保 TF 卡里的资料已备份。
- 卡格式化步骤：在“设置”菜单中连续快速点击“版本更新”后弹出格式化界面，最后点击“格式化 SD 卡”。
- 格式化完成后，手动重启机器即可使用。



小心

- 此符号标志警告可能发生的设备损坏和数据丢失。操作不当，可能导致损坏。



警告

- 此符号标志警告人身伤害危险。操作不当，可能导致人身伤害或设备损坏。

2.5 所用符号标记



提示

- 此符号标志指明帮助您更加高效简便使用设备的信息。



注意

- 此符号标志指明处理或操作设备时必须遵守的各种注意事项。

3 您的音视频记录仪

3.1 设备包含

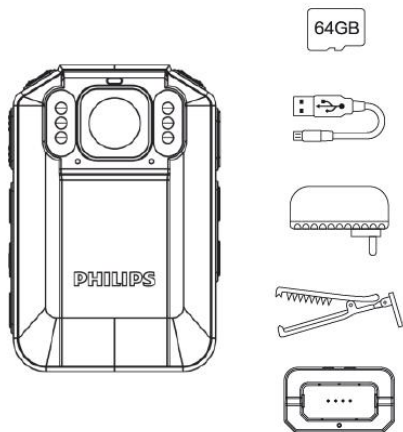

3.2 主机概览

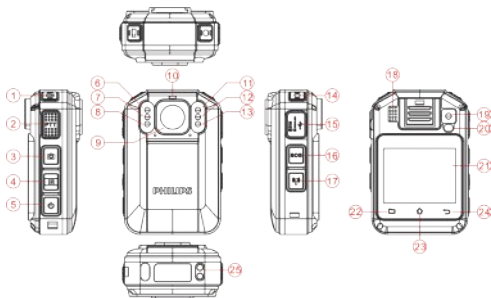

- | | |
|---------|-----------------|
| ① 录像键 | ⑬ 红外灯 |
| ② PTT键 | ⑭ 录音键 |
| ③ 拍照键 | ⑮ USB/SIM/TF卡接口 |
| ④ IR键 | ⑯ SOS键 |
| ⑤ 开关机键 | ⑰ 一键回传 |
| ⑥ 光敏电阻 | ⑱ 喇叭 |
| ⑦ 红外灯 | ⑲ 摄像头 |
| ⑧ 红外灯 | ⑳ 白光灯 |
| ⑨ 摄像头 | ㉑ 屏幕 |
| ⑩ 工作指示灯 | ㉒ 文件夹 |
| ⑪ 白光灯 | ㉓ HOME键 |
| ⑫ 红外灯 | ㉔ 返回键 |

4 开始使用

4.1 开 / 关机



注意

- 第一次使用机器时，请对该机器在关机状态下使用出厂配备的充电器充电 3 小时以确保机器有电工作！

关机状态下，长按开机键，本机自动开机，显示飞利浦图标，如下图所示：



机器进入预览界面，如下图所示，预览状态下，工作状态指示灯亮绿灯。点击屏幕“+”或“-”放大与缩小预览界面，实现数码变焦功能。



按下返回键，返回到主界面，系统主界面如下图所示：



 提示

- 本机使用不可拆卸锂电池供电，如果长时间不使用音视频记录仪，请长按“开关机”按键，出现“关机”和“重启”选项时，选择“关机”主机会正常关机。
- 如果音视频记录仪无法正常工作，请确认机器是否已没电。
- 机器工作过程中，请勿直接把外置卡拔出，否则会损坏文件或导致机器异常。
- 当电量指示标志为时，请及时充电。

4.3 连接电脑

音视频记录仪可作为大容量的 USB 存储设备，无须安装软件，开机直接连接电脑即可。

 提示

- 在文件移入或移出音视频记录仪时，请不要断开音视频记录仪与电脑的连接。
- USB 连接电脑：开机状态下可直接连接；关机状态下则需长按电源键开机，待机器开启后方可连接。

4.2 充电方法

- (1) 使用 USB 数据线将本机与 PC 相连接，充电过程中充电指示灯长亮绿色，充满后熄灭。
- (2) 使用 USB 数据线将本机和出厂配备的充电器进行充电，充电过程中充电指示灯长亮绿色，充满后熄灭。

 提示

- 本机充电可以使用关机充电和开机充电的方式，一般情况下，关机充满电大约需要 4 小时，开机充满电大约需要 5 小时（建议关机充电）。

5 登录执法仪

当您第一次使用执法仪时，开机后设备会自动进入到账号设置界面。您也可以通过点击“设置”进入到设置界面，然后点击“账号设置”，进入到账号设置界面。

	帐号设置	保存
服务器IP	8.129.0.132	
端口号	3503	
设备编号	请输入设备编号	
用户编号	请输入用户编号	

输入服务器 IP、端口号、设备编号和用户编号，点击“保存”按钮，应用会自动重启然后登陆账号。

服务器 IP 默认为 8.129.0.132，端口默认为 3503。







提示

登陆账号前请保证网络连接正常，否则无法正常登陆。

6 录像

当您初次使用音视频记录仪录像时，请注意本节中的内容说明！

- (1) 在摄像预览状态点击录像键开始录像，状态指示灯红灯长亮。
- (2) 点击屏幕“+”或“-”放大与缩小预览界面，实现数码变焦功能。
- (3) 按“”键切换摄像头，再按一下“”键可以切换回来。
- (4) 在黑夜或者光线暗的环境下录像时，按下“”键，照明灯将打开，补充光源，再按“”键关闭白光灯。
- (5) 录音和录像可一键切换，同时保存文件。

录像参考界面如下图所示：

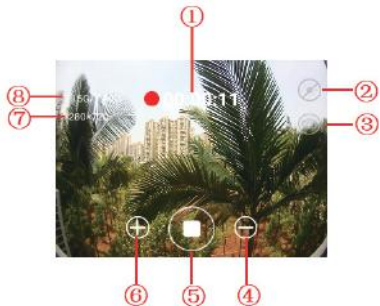
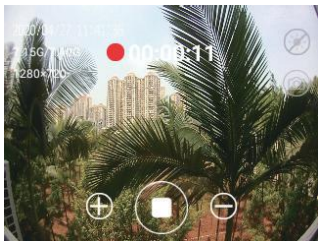

- | | |
|---------|---------|
| ① 录像时间 | ⑤ 录像/停止 |
| ② 白光灯 | ⑥ 放大 |
| ③ 切换摄像头 | ⑦ 分辨率 |
| ④ 缩小 | ⑧ SD卡容量 |

录像界面说明



注意

- 电池标记符显示空格时，表明低电。如果正在录像或者录音，系统自动保存录音文件后关机。电量不足时，请及时充电。低电关机时，显示屏也会有相应的提示，显示屏的提示图标如下所示



提示

- 录像前，请先设置所需的录像参数。

7 拍照

当您初次使用音视频记录仪拍照时，请注意本节中的内容说明！
在摄像预览状态下，直接按拍照键进行拍照，拍照时会有“铛铛”一声，在黑夜或者光线暗的环境下，需要开启机器红外灯或者补光灯进行拍照，在录像状态下，按下拍照按键可以抓拍照片。

8 录音

当您初次使用音视频记录仪录音时，请注意本节中的内容说明！

- (1) 按下“录音键”或点击屏幕的音频采集图标“”开始录音；工作状态指示灯将亮黄灯；请将内置咪头对准音源。
- (2) 按下“录音”键或点击屏幕停止键结束录音同时自动保存录音文件。
- (3) 在录音状态下，按“录像”键结束并保存当前录音，同时切换到录像，再次短按“录音”键结束并保存当前录像，同时切换到录音。

录音参考界面如下所示：



录音界面说明



- ① 返回
- ② 录音时间
- ③ 录音 \ 停止
- ④ 录音状态



提示

- 请先删除一些不必要的文件再录。
- 在录音或者录像过程中禁止直接将卡拔出，否则可能导致文件损坏。
- 录音或者录像时请勿断电，否则可能会导致音视频记录仪故障，文件丢失或文件损坏等问题。
- 如果需要长时间使用，请在录音前充电。

9 视频模式

点击主菜单中的文件图标进入回看界面，点击“视频”选项进入到视频文件回放列表，视频文件列表参考界面如下图所示：



点击播放文件，再点击播放键视频播放暂停。
视频播放参考界面如下图所示：



录像文件播放界面说明:



9.1 视频播放

- (1) 点击屏幕“▶”键开始播放。
- (2) 播放过程中，点击暂停键暂停播放。
- (3) 按“◀”键结束播放，并返回到回放文件列表界面。
- (4) 可通过滑动文件播放进度条选择播放时间点。

- ① 返回
- ② 视频标题
- ③ 总时长
- ④ 进度条
- ⑤ 当前播放时长
- ⑥ 播放 \ 暂停

10 照片模式

点击主菜单中的文件图标进入回看界面，点击“图片”选项进入到图片文件回放列表，图片文件列表参考界面如下图所示：

点击进入照片浏览状态，左右滑动屏幕切换照片。



照片浏览界面如下图所示：



11 语音模式

点击主菜单中的文件图标进入回看界面，点击“音频”选项进入到音频文件回放列表，音频列表参考界面如下图所示：



语音播放列表界面点击播放文件，点击暂停标识暂停播放，按返回键返回播放列表。

语音播放参考界面如下图所示：

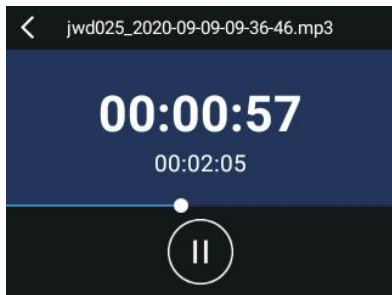

语音文件播放界面说明:

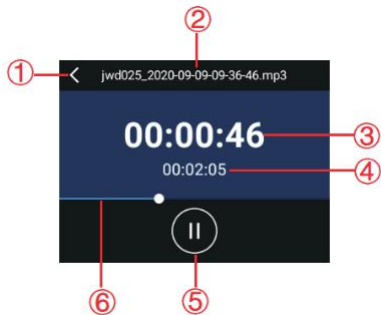

- ① 返回
- ② 音频标题
- ③ 播放时间
- ④ 文件总时长
- ⑤ 播放 / 暂停
- ⑥ 播放进度条

12 视频通话功能

点击主菜单中的视频通话图标进入视频通话界面，视频通话界面如下图所示：



点击列表中的单个设备会提示是否与该设备进行视频通话，点击“确定”按钮即可对该设备发起视频通话功能，点击“取消”则回到视频通话列表界面。

视频通话过程中如下图所示：



大窗口显示对方画面，小窗口显示自己的画面，点击“挂断”按钮则结束本次视频通话。

注意

- 视频通话仅限于一对一视频通话，不支持一对多视频通话。
- 视频通话列表显示为同一分组中的所有成员。

13 集群对讲功能

13.1 组群对讲

点击主菜单中的集群对讲图标进入集群对讲界面，默认为组群对讲，组群对讲界面如下图所示：



点击“>”图标可以查看该组下面的所有成员在线信息，界面如下图所示：



点击列表中的单个组群会提示是否呼叫该组群，点击“取消”则回到组群对讲列表界面，点击“确定”即加入到该组群中，加入组群后，您可以直接进行说话，此时同在当前组群的其他设备即可听到您的声音。组群通话界面如下图所示：





注意

- 组群对讲列表仅显示您当前所加入的组群，如您未加入任何组群，请联系调度平台管理员进行添加。
- 麦克风关闭之后，组群内的成员无法听到您说话的声音。

单一对讲过程中如下图所示：



对讲过程中，点击“挂断”按钮即结束当前对讲。



注意

- 单一对讲仅限于一对一语音对讲，不支持一对多对讲。
- 单一对讲列表显示为同一分组中的所有成员。

13.2 单一对讲

点击主菜单中的集群对讲图标进入集群对讲界面，选择“单一对讲”切换到单一对讲画面，单一对讲如下图所示：



点击列表中的单个设备会提示是否呼叫该设备，点击“确定”按钮即可对该设备发起一对一对讲功能，点击“取消”则回到单一对讲列表界面。

14 GPS 定位

支持 GPS，北斗双模定位，将经纬度显示在显示屏上，并生成实时位置文档，通过调度台回放轨迹。

15 在线翻译

点击主菜单中的在线翻译图标进入在线翻译界面，在线翻译界面如下图所示：

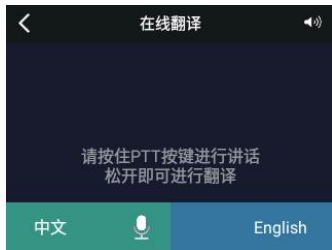

支持中英文互译，按住 PTT 按键进行讲话，松开即可完成翻译，用户可以点击右上角语音播报图标控制是否播报翻译后的内容，可以点击底部中文或 English 区域完成语言切换。按住 PTT 按键进行说话界面如下图所示：



松开 PTT 按键完成识别界面如下图所示：



在线翻译界面功能说明如下图所示：



- ① 返回
- ② 播报开关
- ③ 识别内容
- ④ 翻译后的内容
- ⑤ 英文语言
- ⑥ 选择的语言位置
- ⑦ 中文语言

16 语音转文本

点击主菜单中的语音转文本图标进入语音转文本界面，默认为音频文件选项，音频文件界面如下图所示：

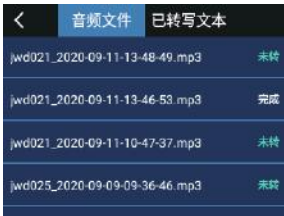

点击已转写文本按钮切换到已转写文本列表界面，如下图所示：



点击音频文件列表或已转写文本列表进入到文件转写界面，文

件转写界面如下图所示：

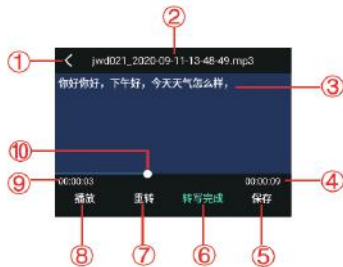

- ① 返回
- ② 文件标题
- ③ 已转写文本内容
- ④ 文件总时长
- ⑤ 保存按钮
- ⑥ 转写状态
- ⑦ 重新转写
- ⑧ 播放 / 暂停
- ⑨ 播放时间
- ⑩ 播放进度条

17 影音设置

在主界面点击影音设置功能图标，系统进入影音设置菜单列表，包括：视频分辨率，照片分辨率，视频帧率，文件时长等功能。

17.1 视频分辨率

视频分辨率有 640×480、1280×720、1920×1080 三个级别，多种录像分辨率选择，可满足大部分应用场合，滑动屏幕选择合适的分辨率。相同数量的视频，分辨率越高的视频所占内存越大。

17.2 照片分辨率

照片分辨率有 高、中、低选择，滑动屏幕选择合适的分辨率。分辨率越高的照片所占内存越大。

17.3 文件时长

使用分段录制功能，可以设置每次录制的文件时间间隔，分段录制设置有 5 分钟、10 分钟、15 分钟、30 分钟四种选择。

18 设置

在主菜单界面点击屏幕设置功能图标，系统进入设置菜单列表。设置菜单列表包括：账号设置，文件上传，WIFI 设置，移动网络设置，流量使用情况，音量设置，日期设置，显示设置，语言，蓝牙设置，PTT 设置，其他设置，关于，版本更新等功能，滑动屏幕选择所需设置的选项，点击进入。

设置界面如下图所示平台设置界面如下图所示：

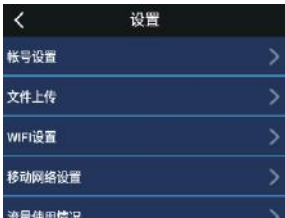

18.1 文件上传

在设置界面点击“文件上传”选项进入到文件上传界面，文件上传界面如下：



用户可根据需要选择单个文件进行上传到服务器，点击“”进入到文件上传设置界面，文件上传设置界面如下图所示：



上传后自动删除本地文件选项打开后，当单个文件上传到服务器成功后，会自动删除本地的当前文件。



注意

· 上传后自动删除本地文件选项默认为关闭。

18.2 WIFI 设置

点击“WIFI 设置”菜单进入到 WIFI 设置界面。

18.3 移动网络设置

点击“移动网络设置”菜单进入到移动网络设置界面。

18.4 流量使用情况

点击“流量使用情况”菜单进入到流量使用情况界面，用户可以查看机器的流量使用情况以及可以对网络进行限制，当后台流量受到限制时，按流量计费的网络会被视为移动网络。在使用此类网络下载大型文件前，会发出警告。

18.5 音量设置

点击“音量设置”菜单进入到音量设置界面，音量设置界面如

下图所示：

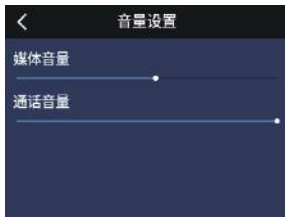

18.6 日期设置

点击“日期设置”菜单进入到日期设置界面，用户可以进行时间修改。

18.7 显示设置

点击“显示设置”菜单进入到显示设置界面，用户可以进行休眠时长和亮度设置，显示设置界面如下图所示：



18.9 版本更新

点击“版本更新”菜单进行检查是否有新版本，有新版本的情况下会弹出软件更新对话框，没有版本更新的情况下，连续点击“版本更新”菜单五次，会进入到格式化 SD 卡界面。

18.8 其他设置

点击“其他设置”菜单进入到其他设置界面，其他设置包括夜视功能和开启语音提示。

夜视功能：

分别有常亮：一直是夜视模式，按键无效化；手动：直接按按键来调整是否开启夜视模式；自动检测：根据光敏电阻即环境来调整夜视模式，同样按键无效化。

支持的语音功能词有：开始录像，停止录像，开始录音，停止录音，开始拍照，打开夜视，关闭夜视，一键报警，返回主界面，返回上一级，结束录像，结束录音，音量增大，音量减小，查看照片，查看视频。

开启语音提示功能打开之后，用户进行录像录音操作会有语音提示。

19 背夹的装拆

19.1 安装背夹

左图所示，将背夹的转接支架与主机的背夹装配槽位对齐，再按箭头方向插入，直至插到底使得背夹的转接支架上的公扣扣入主机的相应凹位为止（右图所示）。

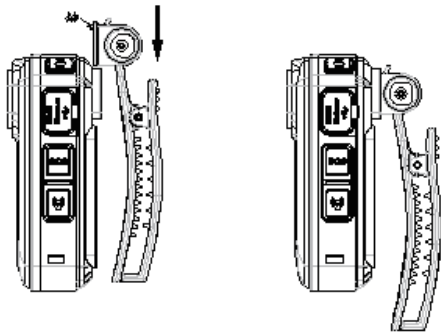

19.2 取下背夹

左图所示，先将背夹的转接支架按图示箭头 1 的方向推，使得转接支架上的公扣与主机的相应凹位分开的同时，按箭头 2 的方向拔出背夹转接支架，直至背夹转接支架与主机完全脱离为止（右图所示）。

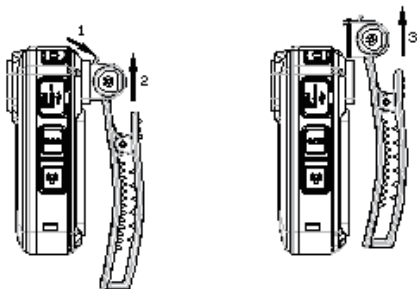

20 背夹的佩戴方式

(1) 左图所示，先按图示箭头 1 方向压住背夹的手夹位，使夹子张口，然后按图示箭头 2 方向朝着肩章两纽扣之间的中部夹入并跨过肩章的宽度，松开手夹位，使夹钩钩住肩章。



(2) 确认夹子钩住肩章后，调整机器至合适的方位。

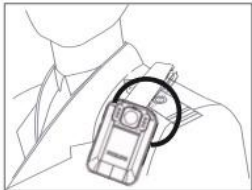

21 常见问题

此处列举了常见问题的解答，可帮助解决执法仪出现的简单问题。如果故障仍无法排除，请咨询经销商或访问我们的官方网站 www.philips.com/support

21.1 无法启动执法仪

电池电量已耗尽请及时充电。

21.2 显示时间 / 日期不正确

执法仪时间不准确，请在菜单上重新设置时间。

21.3 拍照 / 录像图像模糊，不清楚

镜头不干净。请用干净的绒布清洁镜头。

21.4 执法仪无法录音或者录像

执法仪存储空间已满请删除部分文件或将其移至外部存储设备。

21.5 执法仪无法播放录音或者录像

电池电量已耗尽，请充电。

21.6 执法仪死机后如何处理

你有时在操作中会遇到开不了机，黑屏，操作不了等死机现象，通常处理方法是，复位一下，复位键位置：打开 USB 防水盖子，USB 座旁边有一小孔，用镊子或尖的东西点按一下小孔即可。
注：本操作不会造成文件数据丢失或者损坏。

22 技术参数

22.1 存储器

内置存储器类型：C10 TF 卡

22.2 尺寸和重量

宽 × 高 × 深：83 × 55 × 26 (mm)

重量（含电池）：176g

22.3 系统要求

操作系统：Windows10/8/7, Mac OS

接口：MICRO USB 接口

22.4 录音

长时间

22.5 运行条件

温度：-30°C – 55°C

空气湿度：10% – 90%，不凝结

Content

1 Welcome	40
1.1 Product Features	40

2 Important Notice	42
2.1 Safety	42
2.2 Hearing Protection	42
2.3 Legal Restriction on Recording	42
2.4 Background Data	42
2.5 Icons Used	43

3 Your Audio/Video Recorder	44
3.1 What's in the box	44
3.2 Overview	44

4 Start to Use	45
4.1 Turn ON/OFF	45
4.2 Charging Methods	46
4.3 Connecting to Computer	46

5 Log in	47
-----------------	-----------

6 Video Recording	48
--------------------------	-----------

7 Photo	50
----------------	-----------

8 Voice Recording	51
--------------------------	-----------

9 Video Mode	53
9.1 Video Playing	54

10 Photo Mode	55
----------------------	-----------

11 Audio Mode	56
----------------------	-----------

12 Video Call Function	58
-------------------------------	-----------

13 Group Chat Function	59
13.1 Groups Chat	59
13.2 Single Intercom	60

14 GPS Positioning	62
---------------------------	-----------

15 Online Translation	63
------------------------------	-----------

16 Voice to Text 65

17 Media Setting 67

- 17.1 Video Resolution 67
 - 17.2 Photo Resolution 67
 - 17.3 File Time 67
-

18 Settings 68

- 18.1 Upload Files 68
 - 18.2 WIFI Setting 69
 - 18.3 Mobile Network Setting 69
 - 18.4 Flow Usage 69
 - 18.5 Volume Setting 69
 - 18.6 Date Setting 70
 - 18.7 Display Settings 70
 - 18.8 Other Settings 70
 - 18.9 Version Update 70
-

19 Mounting of Shoulder Clip 71

- 19.1 Mounting of Shoulder Clip 71
 - 19.2 Dismounting of clip 71
-

20 Wearing Shoulder Clip 72

21 FAQ 73

- 21.1 Unable to start 73
 - 21.2 Incorrect time/date 73
 - 21.3 Unclear image/video 73
 - 21.4 Unable to record audio/video 73
 - 21.5 Unable to play audio or video files 73
 - 21.6 How to respond to dead halt 73
-

22 Technical Parameters 74

- 22.1 Memory 74
- 22.2 Dimensions & Weight 74
- 22.3 System Requirements 74
- 22.4 Recording 74
- 22.5 Operational Conditions 74

1 Welcome

Welcome to the World of Philips! We feel delighted that you choose to buy from Philips. You can always visit our website to get all-inclusive technical support from Philips, including user manual, software download and information on warranty information.

www.philips.com

1.1 Product Features

- Front and rear cameras: switchable camera for video recording and photo taking.
- Voice control: voice wake for voice/video recording, photo taking, etc.
- Online translation: support online synchronous multi-language translation.
- Voice to text: recording files can be converted to text.
- Quick Voice Recording: Simply press the Voice Recording button for the first time to record, and the second time to save recorded clips.
- Quick Video Recording: Simply press the Video Recording button for the first time to record, and the second time to save recorded clips.
- Quick photograph: Simply press the Photo button to take photos.
- Quick video calling: Simply press the Video calling button to make video call with dispatching platform.
- Quick SOS: Simply press SOS to report the information to the dispatching platform (the function is only active after you connect to network and login account. If not be logged in, "Unconnected to the server" will pop up)..
- Group Voice Chat: Simply press the PTT to start the groups chat.
- Use stereo sound technology for voice/video recorder.
- Use smart audio coder/decoder and dual-mic technologies to reduce voice and improve sound quality.
- 160° super-wide angle lens for getting a fuller picture.
- Use dual filter switch to prevent color cast during daytime and clearer during nighttime.
- On-Screen Display function ensures that all videos and photos contain un-editable timing, product serial number and user serial number that ensure legal validity of such evidence.
- Super long file name: All recorded video files contain information such as product serial number, recording time and user serial number, which ensure convenient data storage and retrieval.
- All recorded video files are automatically cut and saved to prevent data loss due to incorrect operation.

- External memory card supports 256G.
- High-definition speaker: Use high-quality vibration speaker to give you a live feel during audio or video play.
- Use high-speed USB 2.0 to ensure quick storage of audio/video files.
- Large-volume USB storage device to ensure maximum compatibility.

2 Important Notice

2.1 Safety



Warning

- Special Announcement: Before using the product, please read the Manual carefully. The Company shall not be held liable for any data loss due to incorrect manual operation or force majeure. We specially recommend that users make additional copies of the files in the device.
- Images are for reference only. Philips reserves the right to change the color/appearance/design/parameters/product functions without prior notice.

2.2 Hearing Protection

When using the earphone, please follow the instructions below:

- Adjust to appropriate volume and avoid long-time use of the earphone.
- Special warning: Do not adjust the volume beyond the allowable capacity of your ears.

- Do not adjust volume to a level higher than the ambient volume.
- Stop or suspend the use of your earphone in case of dangers.
- Do not use your earphones when you are driving a car, a bicycle or a skateboard. Otherwise, you will be violating traffic laws and other related laws.

2.3 Legal Restriction on Recording

- Use of the recording function of this device is subject to the restrictions imposed by national laws. When recording the conversations or courses of others, you should respect the privacy and other rights of such persons.
- Please note that in some countries, the user must notify the other party when he/she is recording his/her conversations with such other party. Otherwise, such recording activity might be considered as illegal. Please ensure the lawfulness of the recording activity in any applicable jurisdiction.

2.4 Background Data

- Upon the activation of the system, the Company provides a one-year warranty. If you require our

services after expiration of the warranty, please call 400-800-7890.

- The background system only keeps audio/video data for only 3 days. Please make backup copies to prevent data loss to which the Company shall not be held liable.



Notice

- The TF card of 64GB or above must be formatted in this device for the first time.
- -Before formatting, please make sure that the data in the TF card be backed up.
- · Card format steps: click "Version update" in "Settings" continuously for several times, and the format interface will pop up, then please click "Format SD card".
- -After formatting, restart the device manually to use.



Notice

- This icon gives you various notices on handling or operation of the device.



Caution

- This icon means warning on potential loss of data or damage to device. In case of inappropriate operation, damage might be caused to the device.



Warning

- This icon warns you about personal injury. In case of inappropriate operation, damage might be caused to your person or device.

2.5 Icons Used



Reminder

- This Icon gives you convenient and easy-to-use information on the device.

3 Your Audio/Video Recorder

3.1 What's in the box

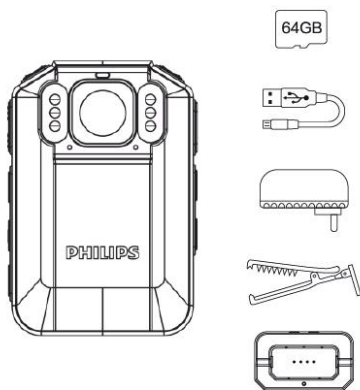

3.2 Overview

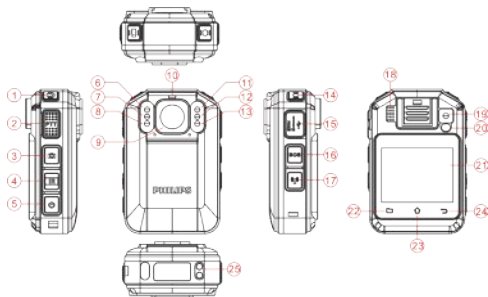

- ① Video recording button
- ② PTT button
- ③ Photo button
- ④ R button
- ⑤ ON/OFF
- ⑥ Photoresistor
- ⑦ Infrared light
- ⑧ Infrared light
- ⑨ Camera
- ⑩ Working indicator
- ⑪ White light
- ⑫ Infrared light
- ⑬ Infrared light
- ⑭ Recording button
- ⑮ USB/SIM/TF card slot
- ⑯ SOS button
- ⑰ Quick video uploading
- ⑱ Speaker
- ⑲ Camera
- ⑳ White light
- ㉑ Screen
- ㉒ Folder
- ㉓ HOME button
- ㉔ Return button

4 Start to Use

4.1 Turn ON/OFF



Notice

- When using the device for the first time, please shut down the device and charge it with original charger for 3 hours!

During shutdown mode, long press Turn ON button, and the device will be turned on, showing the Philips logo, as shown below:



When entering the preview interface as shown below,

you will see the indicator show green light. Click "+" or "-" to zoom in or zoom out.

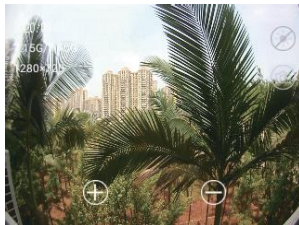

Press Return button to return to the Main Interface which shows the following:

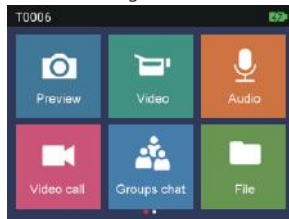

Reminder

- The device uses undetachable lithium batteries. If the device is left unused for a long time, please long press "ON/OFF" button to choose from "Shutdown" and "Restart". When you choose Shutdown, the device will be shut down normally.
- If the record does not work properly, please check if the device is out of power.
- During operation please do not pull out the external memory card. Otherwise, damage might be caused to the files or the device.
- When battery volume shows , please charge your device timely.

4.2 Charging Methods

- (1) Use USB cable to connect the device with PC, the indicator will show green light during charging, which will be extinguished after the device is fully charged.
- (2) Use USB data cable and the connector to charge the device. The device indicator will show green light first, which will be extinguished after the device is fully charged.

Reminder

- The device can be charged either during ON or OFF mode. Normally, during OFF mode charging, it takes around 4 hours for full charging. During ON mode, it takes around 5 hours for full charging (we recommend that you use OFF mode charging).

4.3 Connecting to Computer

The recorder can be used as a large-volume USB storage device, which can be connected to the computer. No software needs to be installed, the recorder will be connected directly to the computer.

Reminder

- When importing/exporting the files from or to the device, do not disconnect the recorder from the computer.
- USB connect to PC: they can be directly connected when the device is turned on; when the device is off, please press the power button and connect the computer after the device is turned on.

5 Log in

When you use the device for the first time, it will automatically enter the "Account Setting" after turning on. Also, you can enter the Settings interface by clicking "Settings" and "Account".



The screenshot shows a mobile application interface titled "Account" with a "SAVE" button in the top right corner. The interface contains four input fields:

Field Label	Value
Server	8.129.0.132
port number	3503
Equipment serial number	Input device ID
user ID	Input user ID

Please input the server IP, port number, Equipment serial number and User ID, and click "Save" button. The application will automatically restart and log in the account. The server IP is 8.129.0.132 and the port number is 3503 by default.



Reminder

- Please ensure that the network connection is normal before logging in , otherwise it will fail to log in.

6 Video Recording

When you use the recorder for the first time, please pay attention to the requirements in this section!

- (1) In the preview mode, please click "Video" button to record and the indicator light will show red light.
- (2) Click "+" or "-" on the screen to zoom out or zoom in.
- (3) Press "📷" button to switch the camera, press "📷" button again can switch back.
- (4) When recording in dark or dim light, press "🔦" button to turn on the illumination light, press "🔦" button again to turn it off.
- (5) You can switch from Audio Recording to Video Recording while saving the files.

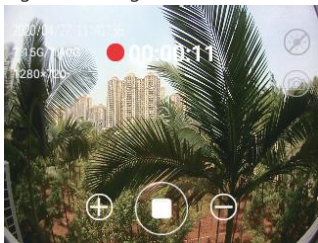

Recording Interface Illustration

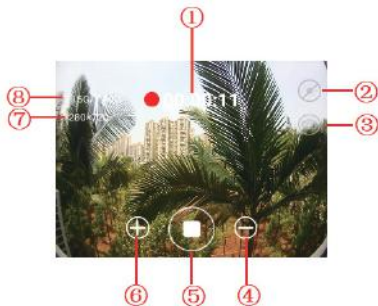

① Video recording button

② White light

③ Switch camera

④ Digital zooming -

⑤ Record/Stop

⑥ Digital zooming +

⑦ Resolution

⑧ SD card capacity

Notice

- When the battery icon is showing empty, it means low on battery. If you are recording, the system will automatically save the recorded files. In case of low battery, please charge your device timely. During low battery, the device gives you "Low Battery" notice as shown below:



Reminder

- Before recording, please adjust the recording parameters first.
- Please delete some unnecessary files first.

7 Photo

When you use the device for photo taking for the first time, please read the instructions in this section!

During the video recording mode, press the Photo Taking button and a “ding-ding” sound will occur during photo taking. In dark or dim light, you need to turn on the infrared light for photo taking. During video recording mode, press Photo button to capture a photo.

8 Voice Recording

When you use the device for audio recording for the first time, please read the instructions in this section!

- (1) Press "Voice Recording Button" or click the audio recording icon "●" to start recording. The indicator will show yellow light during work mode. Please adjust the imbedded mic to the sound source.
- (2) Press "Audio Recording" button or click the pause button to save to save the recorded clips.
- (3) During the Audio Recording mode, press "Video Recording" button to end recording and save recorded audio clips, while shifting to the Video Recording mode. Press "Voice Recording" to end recording and save video clips, while shifting to the Audio Recording mode.

The reference audio recording interface is shown below:

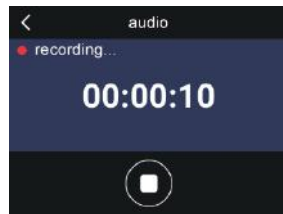

Audio Recording Illustration



- ① Return
- ② Recording Time
- ③ Recording/Pause
- ④ Recording Status



Reminder

- Please delete some unnecessary files before recording.
- Do not pull out the memory card during audio/video recording mode. Otherwise, damage might be caused to the files.
- Do not cut off power during audio/video recording mode. Otherwise, damage might be caused to the recorder and the files might be lost or damaged.
- If you intend to use the device for a long period of time, please charge the device before recording.

9 Video Mode

Click the File icon in the main menu to enter the video resaw file list, as shown below:

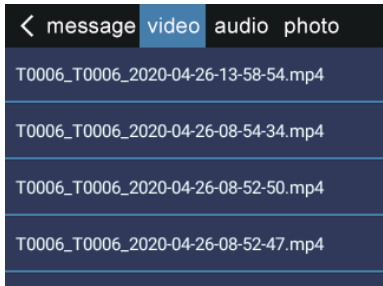

Click the file you want to play and click again to pause. The video playing interface as shown below:



Recorded File Playing Illustration



- ① Return
 - ② Video title
 - ③ Total Time
 - ④ Play Progress Bar
 - ⑤ Current Play Time
 - ⑥ Play/Pause
-

9.1 Video Playing

- (1) Click "▶" button to play video.
- (2) During playing mode, click "⏸" to suspend playing.
- (3) Press "◀" button to end playing and return to the file menu.
- (4) You can also slide the playing bar to choose the playing point.

10 Photo Mode

Click the File icon in the main menu to enter the resaw interface, and click the "Photo" option to enter photo file resaw list. The photo file list is shown in the following:

Click to browse the photos and switch them by sliding the screen left and right.



The photo browsing interface is shown in the following figure:



11 Audio Mode

Click the File icon in the main menu to enter the resaw interface, and click "Audio" option to enter audio file resaw list. The audio file list is shown in the following:

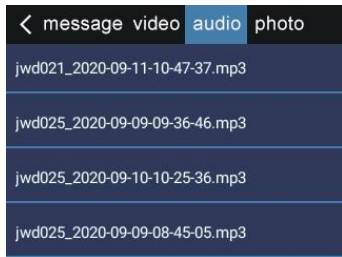

Click the file for playing in the audio play list interface, click "⏸" icon to stop playing and press "⏪" button to return to the playlist.

The audio playing interface is shown as below:

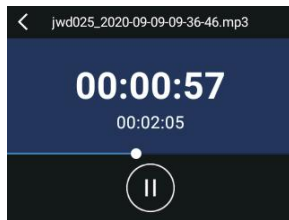

Audio File Playing Interface Illustration:

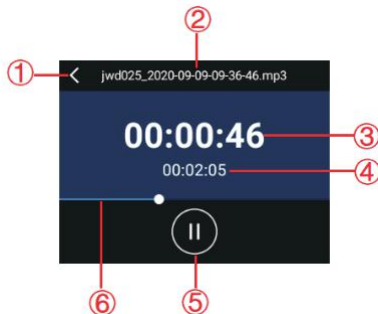

- ① Return
- ② File name
- ③ Play time
- ④ Total time
- ⑤ Play/Pause
- ⑥ **Play progress bar**

12 Video Call Function

Click the Video call icon in the main menu to enter the video call interface, which is shown in the following:

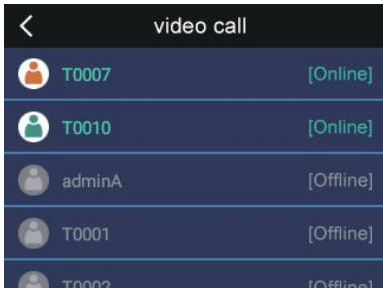

Click a device in the list to prompt "Whether to make a video call with the device" and click "OK" button to start a video call, and click "Cancel" to return to the video call list interface.

The video call is shown as below:



The bigger window displays the picture of the other party, and the smaller window displays your own picture. Click "Hang up" button to end the video call.



Notice

- Video calls are limited to one-to-one video call and do not support one-to-many video calls.
- The video call list displays all members in the same group.

13 Group Chat Function

13.1 Groups Chat

Click the Groups Chat icon in the main menu to enter the group talk interface, as shown in the below:

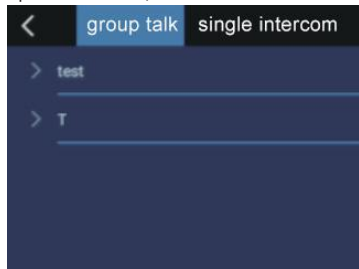

Click ">" to view the all members' online information of the group. The interface is as follows:

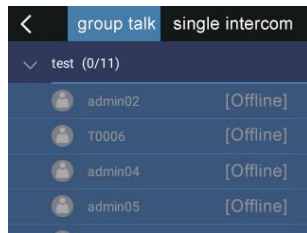

Click a group in the list to prompt "Whether to call the group", click "Cancel" to return to the group chat list and "OK" to join the group. After joining a group, you can speak directly. At the same time, other devices in the current group can hear your voice. The group talk interface is shown as below:

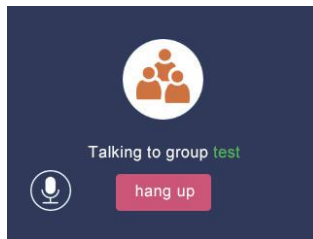



Notice

- VThe group talk list only shows the group you are currently joining. If you do not join any group, please contact the administrator to add.
- When the microphone is turned off, members of the group cannot hear you.

13.2 Single Intercom

Click the Groups Chat icon in the main menu to enter the groups chat interface, and select “Single intercom” to switch to the single intercom interface, as shown in the following:

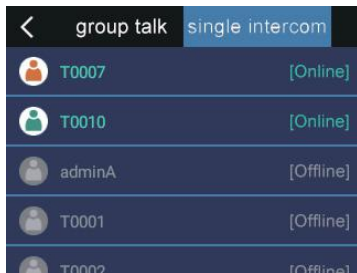

Click a device in the list to prompt “Whether to call the device”. Click “OK” button to start single intercom and “Cancel” to return to the single intercom list. The single intercom is shown as below:

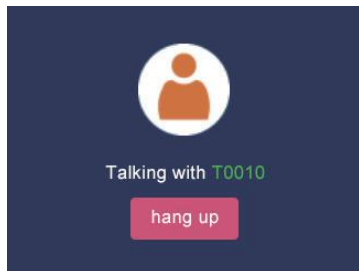

During intercom, click the “OK” button to end the current intercom.

Notice

- Single intercom is limited to one - to - one speech intercom and does not support one - to - many intercom.
- Single intercom list is displayed as all members of the same group.

14 GPS Positioning

The device supports GPS function and Beidou dual-mode positioning. The longitude and latitude are shown on the screen to produce a real-time location file. The tracking record can be obtained at the dispatcher.

15 Online Translation

Click Translation icon in the main interface to enter the online translation interface, which is shown in the following:



The device supports Chinese-English & English- Chinese translation. Please press and hold PTT to speak and release to complete the translation. Press and hold the PTT button to speak and release to complete the translation. Click the voice broadcast icon in the upper right corner to control whether to broadcast the translated content. Click the Chinese or English at the bottom to switch language.

Press and hold the PTT button to speak, as shown below:

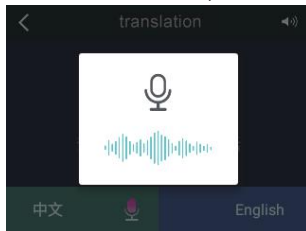

English

Release the PTT button to complete recognition, as shown below:



The function of online translation interface is as follows:



- ① Return
- ② Broadcast on-off
- ③ Recognized content
- ④ Translated content
- ⑤ English
- ⑥ Language choice
- ⑦ Chinese

16 Voice to Text

Click the voice to text icon in the main menu to enter the voice to text interface, which is the audio file by default. The audio file interface is shown in the following:

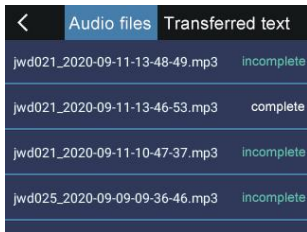

Click "Transferred text" to enter transferred text interface, as shown in the following:

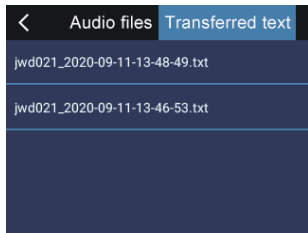

Click the audio file list or the transferred text list to enter the file transfer interface, as shown in the following:

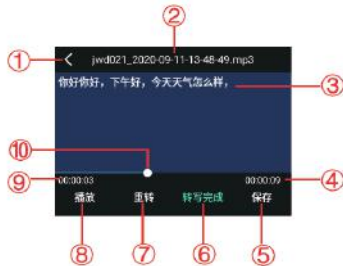

- ① Return
- ② File name
- ③ Transferred text
- ④ Total time
- ⑤ Save
- ⑥ Transcribe complete
- ⑦ Re-transfer
- ⑧ Play/Pause
- ⑨ Time
- ⑩ Progress bar

17 Media Setting

Click Media setting icon in the main interface to enter the menu list of media setting, including video resolution, photo resolution, video frame rate, file time, etc.

17.1 Video Resolution

The resolution includes three levels: 640×480, 1280×720 and 1920×1080. These options can meet most of your needs under various scenarios. You can slide on the screen to choose the appropriate resolution. For the same number of videos, the high resolution videos will take up more internal storage.

17.2 Photo Resolution

Various photo resolution can be selected: High, Medium, Low. You can select the appropriate resolution by sliding the screen. The high resolution photos will take up more internal storage.

17.3 File Time

You can Use the segment recording function to set the file time interval for each recording. There are four options: 5 minutes, 10 minutes 15 minutes and 30 minutes.

English

18 Settings

Click Settings icon in the main menu interface to enter the settings menu. The menu list of settings includes: Account, Upload, WIFI, APN, Folw usage, Voice, Date, Display, Language, Bluetooth, PTT, Other, About, Version update and other functions. Slide the screen to select the desired option.

The setting interface is shown in the following figure, and the platform setting interface is shown in the following figure:

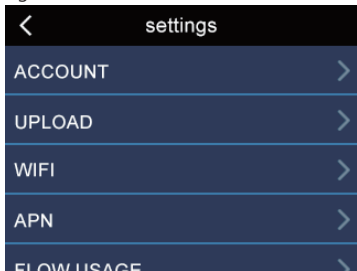

18.1 Upload Files

Click "Upload" in the setting interface to enter the file upload interface. The interface is as follows:

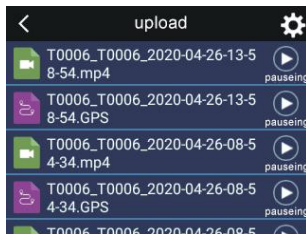

You can select a file to upload to the server based on your needs, and click "⚙️" to enter the file upload setting interface. The file upload setting interface is shown in the following :

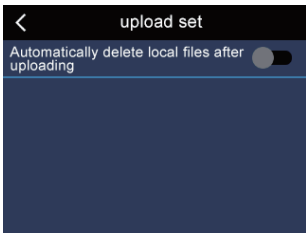

After the “Automatically delete local files after uploading” option is turned on, if a file is successfully uploaded to the server, the local file will be automatically deleted.



Notice

- The “Automatically delete local files after uploading” option is off by default.

18.2 WIFI Setting

Click “WIFI” to enter the WIFI setting interface.

18.3 Mobile Network Setting

Click “APN” to enter the Mobile network setting.

18.4 Flow Usage

Click “Flow usage” to enter the data usage interface. You can view the data usage and restrict the network. When the background data is limited, the network charged by data will be regarded as a mobile network. A warning is issued before downloading large files.

18.5 Volume Setting

Click “Voice” to enter the volume setting interface, which is shown as follows:

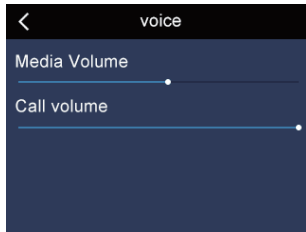

18.6 Date Setting

Click "Date" to enter the date setting interface and you can set the date.

18.7 Display Settings

Click "Display settings" to enter the display setting interface and you can set sleep time and brightness.

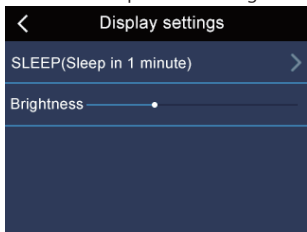

18.8 Other Settings

Click "Other" to enter others settings interface, which includes Night vision and Voice activation.

Night vision:

Always on: it's always the night vision mode, the button invalid. Manual: press the button directly to adjust whether to open the night vision mode. Automatic detection: adjust the night vision according to the photo-sensitive resistance, the button also is invalid.

The supported voice function words are: start video recording, stop video recording, start audio recording, stop audio recording, start taking pictures, turn on night vision, turn off night vision, one-touch alarm, return to the main menu, return to the upper level, end voice recording, end audio recording, volume up, volume down, view photos and video.

After the voice activation function is turned on, you will have voice prompt for video recording operation.

18.9 Version Update

Click "Version update" menu to check whether there is a new version. If there is, the update dialog box will pop up. If there is no version for updating, please click "Version update" five times continuously to enter the format SD card interface.

19 Mounting of Shoulder Clip

19.1 Mounting of Shoulder Clip

As shown in the figure on the left, align the adapter bracket with the assembly slot, and then insert it in the direction of the arrow until the male thread on the adapter bracket fits into the corresponding slot of the device (as shown in the figure on the right).

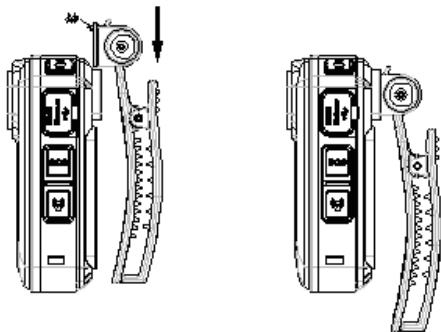

19.2 Dismounting of clip

As shown in the figure on the left, push the adapter bracket in the direction of arrow 1, so that the male thread on the adapter bracket is separated from the corresponding slot of the device. In the meantime, pull out the adapter bracket in the direction of arrow 2 until the adapter bracket is completely separated from the device (as shown in the figure on the right).

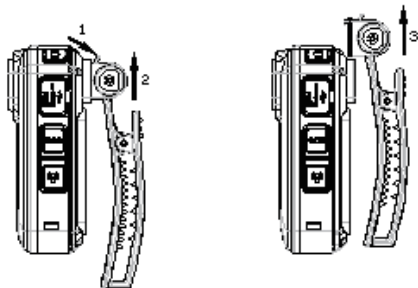

20 Wearing Shoulder Clip

- (1) As shown in the figure on the left, press the hand clip in the direction of arrow 1 to open the clip, then clamp the middle of the shoulder strap in the direction of arrow 2 and release the hand clip, so that the hook can catch the shoulder strap.



- (2) Make sure that the clip hooks the shoulder strap and adjust the device to an appropriate position.

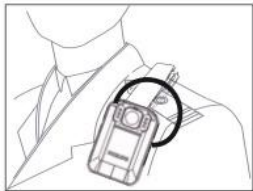

21 FAQ

This section has listed all the frequently asked questions to help you address the simple issues during use of the device. If such issues persist, please consult our dealers or visit our official website: www.philips.com/support.

21.1 Unable to start

The battery has run out and you need to charge your device.

21.2 Incorrect time/date

It means inaccurate timing setting. Please reset the time and date in the menu.

21.3 Unclear image/video

Unclean lens has caused it. Please use clean cloth to clean it.

21.4 Unable to record audio/video

The internal storage has run out. Please delete some of the files or transfer such files to external storage device.

21.5 Unable to play audio or video files

The battery is used up, please charge your device.

21.6 How to respond to dead halt

If you are unable to start the device, face black screen and operational failure, the normal technique is to reset: Pull out the USB and there is a small hole in the slot. Use a sharp tool to drill into the small hole.

Note: This operation will not cause data loss or destruction.

22 Technical Parameters

22.1 Memory

External Memory

Standard Recording Hours (64GB): 217 hours for stereo sound mode

Type of Internal Storage: C10 TF card

22.2 Dimensions & Weight

Width* Height*Depth: 83×55×26 (mm)

Weight (including Battery): 176g

22.3 System Requirements

Operating System: Windows10/8/ 7, Mac OS

Port: MICRO USB Port

22.4 Recording

SLP

22.5 Operational Conditions

Temperature: -30°–55°C

Humidity: 10%-90%, uncondensed

Warranty card

质保书

1

year warranty

一年质保

Type: VTR8410

Serial nr:

Date of purchase

购买日期

Dealer's name, address and signature

销售商名称、地址及签字

www.philips.com/welcome

This document is printed on chlorine free produced paper

Data subject to change without notice

This product was brought to the market by Speech Processing Solutions GmbH or one of its affiliates, further referred to in this document as SPS, which is the manufacturer of the product. SPS is the warrantor in relation to the product with which this booklet was packaged.

For China only
只限中国地区

Printed in China



